

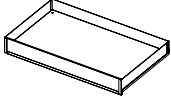

WPD-PSA Pull Out Drawer Installation Instruction

Acce. List

Drawer	450mm Slide	Screws	Rear Hood Block
1 PCS	1 SET	6 PCS	2 PCS
	 L R		

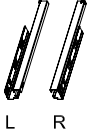

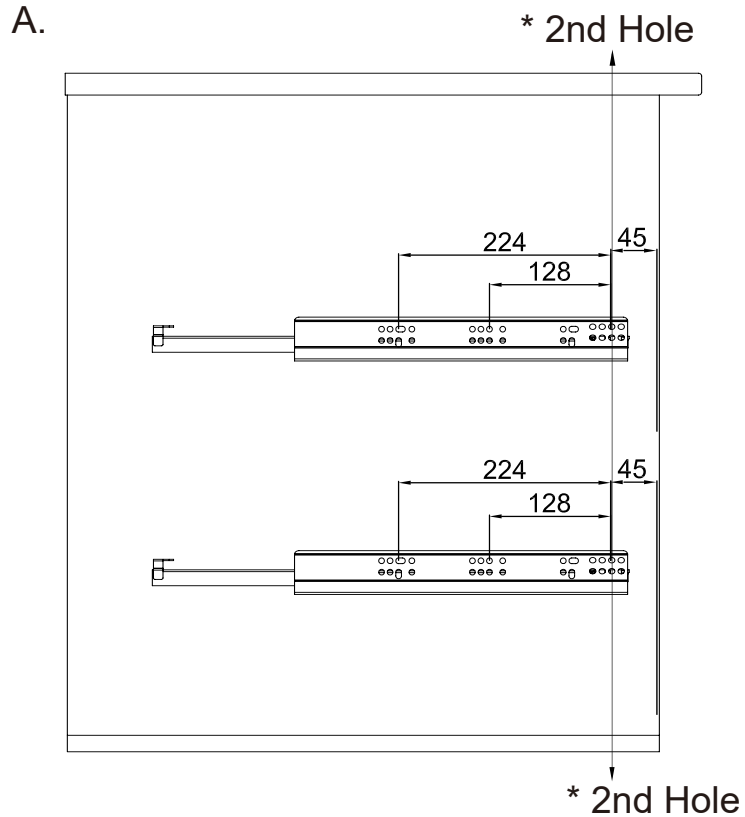
B. Ensure that the Rear Hook Block of the slide is properly installed.

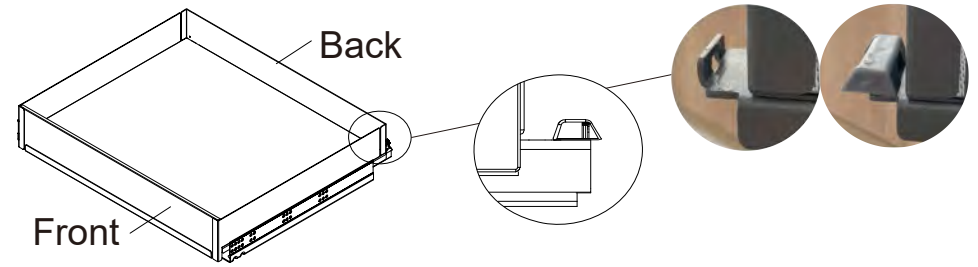

C. If side panel is 16mm, remove 2 back foam pads on each side of the drawer (underneath)

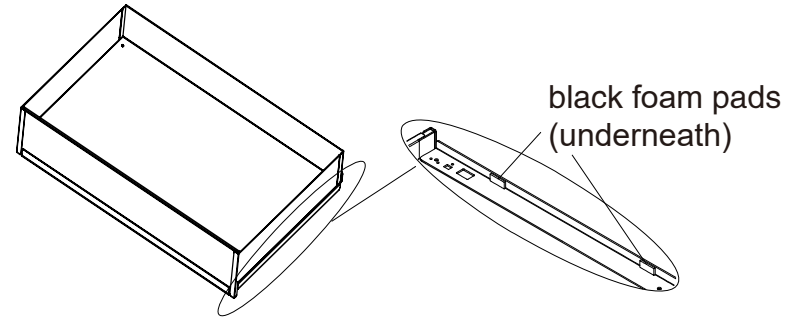

D.

